

 **Matsura**

5-Axis Vertical Machining Center

MX-330



MAXIA
Innovation by  Matsura

Matsuura MX-330

Introducing the **MX-330** the latest addition to our market leading entry level 5 axis machine series

Features

- **Matsuura** hand-built 5 axis quality; exceptional performance, low cost of ownership & assured residual value.
- Manned or Unmanned; ergonomic & dynamic design performance assures productivity.
- Equipped with the **Matsuura G-Tech 31i**; touch screen with large display for operator comfort & precise control.

MAXIA BT40 Spindle Lineup

From high speed aluminum machining to pre-hardened steels; the MAXIA spindle options offered with the **MX-330** are the pinnacle of 70 years of prestigious **Matsuura** spindle technology. A 15000min⁻¹ with 65.1N · m of torque is installed as standard. A high-power 15000min⁻¹ with 119.3N · m and a high-speed 20000 min⁻¹ with 108.4N · m are available as options.

Automation & Unmanned Package Option

Matsuura's legendary unmanned running technology with the **MX-330** comes in the form of a 10 pallet (CAPTO C6 compatible) & 90 tool option; offering superb profit enhancing lights out production utilizing minimal floorspace.

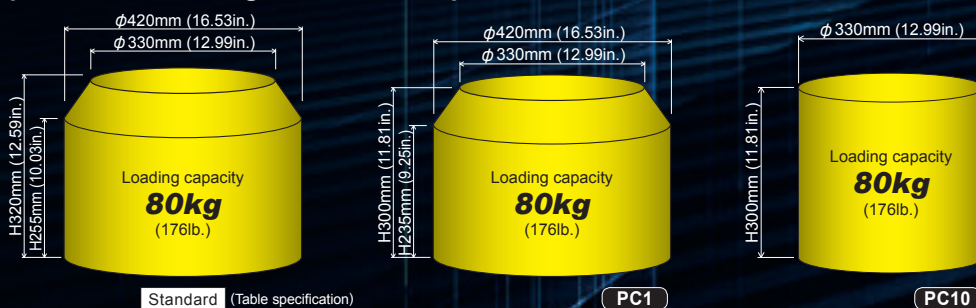



New!

PC10

MAXIA
Innovation by  Matsuura

MAXIA BT40 Spindles; The Industry Standard, Designed and Developed by **Matsuura** – the pioneers of highly rigid CNC Spindle Technology

Three State of the Art **MAXIA** Spindle Lineup;
Built upon 70 years of **Matsuura** excellence



- In built reliability by superior design and sustained spindle performance from **Matsuura**'s engineering heritage.
- From high speed aluminum machining to pre-hardened steels; the exceptional performance in all machining environments is assured. A 15000min⁻¹ with 65.1N·m of torque is installed as standard. A high-power 15000min⁻¹ with 119.3N·m and a high-speed 20000 min⁻¹ & 108.4N·m are available as options.
- **Matsuura** control every aspect of our **MAXIA** Spindles creation; from design concept, to precision in-house component manufacture, to clean room assembly, to rigorous testing, to final installation & commission. Quality assurance & sustained Spindle performance – every time.
- Maintenance free Spindle technology; grease lubricated, low noise, environmentally friendly.



Standard 15000min⁻¹ (5.5 / 7.5kW, 65.1N·m)

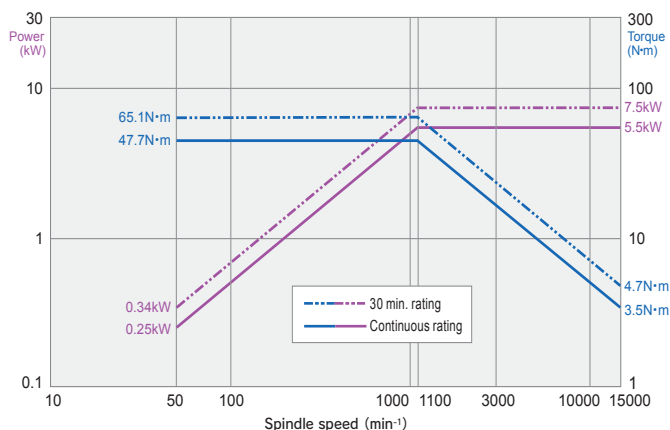

Option High-power type spindle
15000min⁻¹ (7.5 / 15kW, 119.3N·m)

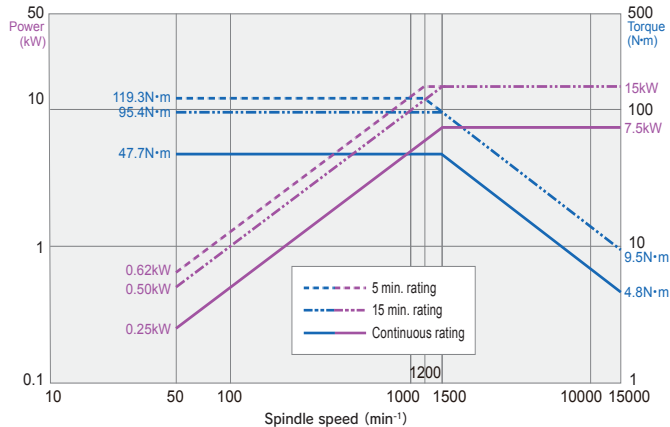

Option High-speed type spindle
20000min⁻¹ (11 / 15, 15 / 18.5kW, 108.4N·m)

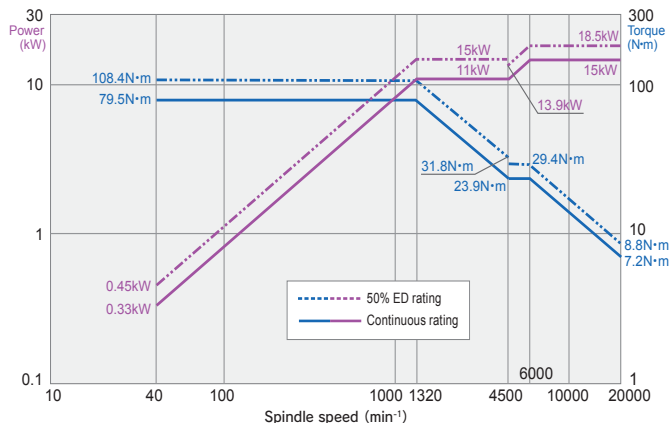

Classic *Matsuura* Machine Build; a Commitment to Engineering Excellence

Machining any material for sustained periods of time to incredible accuracy requires the most rigid & tested machining structure. Designed with FEM analysis utilizing many decades of *Matsuura* machine know-how & heritage, the **MX-330** is the 5 axis platform for the precise creation of small components, where quality and sustained performance is a pre-requisite.

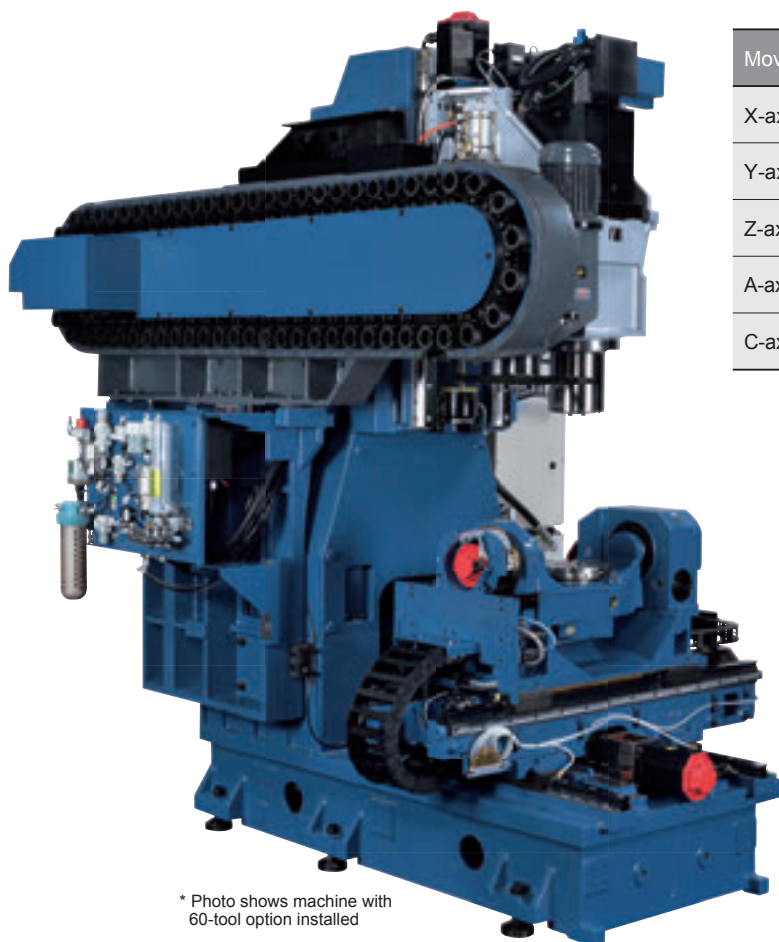

* Photo shows machine with 60-tool option installed

Movement and Ranges		
X-axis stroke	mm (in.)	435 (17.13)
Y-axis stroke	mm (in.)	465 (18.31)
Z-axis stroke	mm (in.)	560 (22.05)
A-axis rotation angle (rotation on the X axis)	deg	-125 ~ +10
C-axis rotation angle (rotation on the Z axis)	deg	360

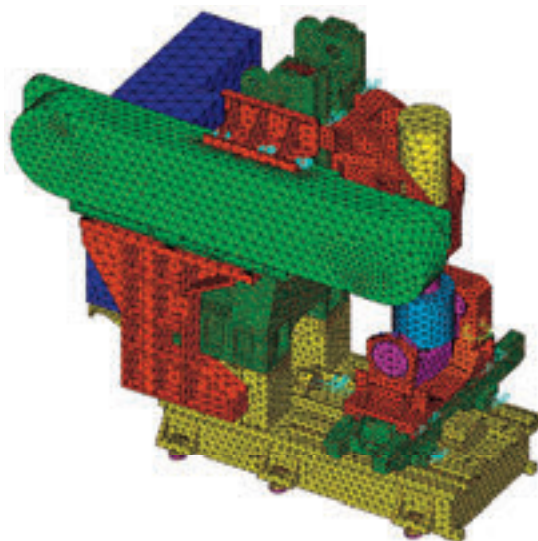

■ Cutting test results Option (High-power type spindle BT40 15000min⁻¹, 119.3N·m)

	Part material	Tool size	Cutting width Cutting depth	Spindle speed	Cutting feed rate	Cutting capacity		Part material	Tool size	Spindle speed	Cutting feed rate	Cutting capacity
	Aluminum	Ø80mm (3.14) 3 blades	W=70mm (2.75) D=4mm (0.15)	5500 min ⁻¹	5500 mm/min (216.53)	1540 cc/min		Aluminum	Ø33mm (1.29)	1500 min ⁻¹	450 mm/min (17.71)	385 cc/min
	Steel	Ø80mm (3.14) 5 blades	W=70mm (2.75) D=2.5mm (0.09)	1400 min ⁻¹	2000 mm/min (78.74)	350 cc/min		Steel	Ø33mm (1.29)	1200 min ⁻¹	200 mm/min (7.87)	171 cc/min
	Aluminum	Ø25mm (0.98) 2 blades	W=22mm (0.86) D=6mm (0.23)	15000 min ⁻¹	8500 mm/min (334.64)	1122 cc/min		Aluminum	M36 × P4.0	120 min ⁻¹	480 mm/min (18.89)	
	Steel	Ø20mm (0.78) 4 blades	W=3mm (0.11) D=30mm (1.18)	5000 min ⁻¹	4200 mm/min (165.35)	378 cc/min		Steel	M24 × P3.0	100 min ⁻¹	300 mm/min (11.81)	

* The above data is based on actual cases. Depending on conditions, actual results may differ.

Options; Tailored to Your Process

ATC

■ 30-tool drum magazine Standard

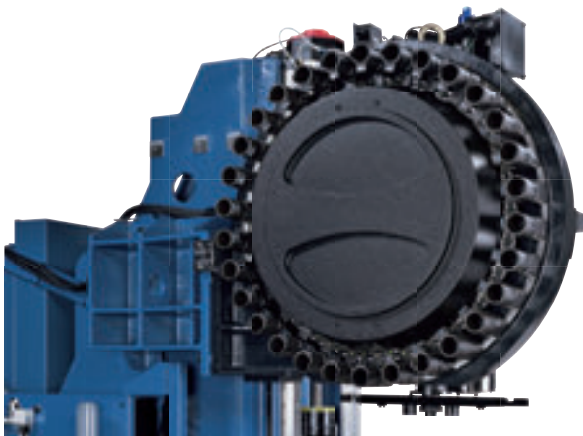

■ 60-tool chain magazine Option



■ Tool specification

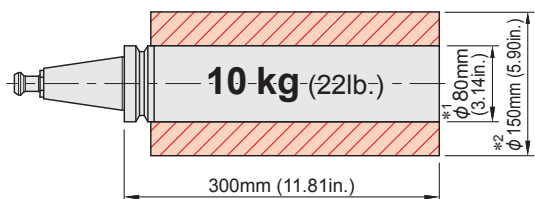

Standard BT40 Option HSK-A63

*1 With adjacent tools

*2 Without adjacent tools

■ 90-tool chain magazine Option

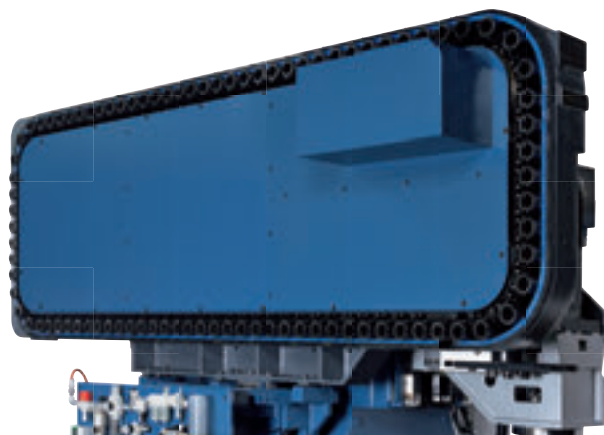

4th / 5th axis rotary table

As with all machines in the **MX** Series, a proven, high performance trunnion table is utilized on the **MX-330**.

■ φ250mm table Standard

Fixtures used with **MAM72-35V** can be mounted.



■ 6-port through-table Option
(Max. supply pressure 19.6MPa)

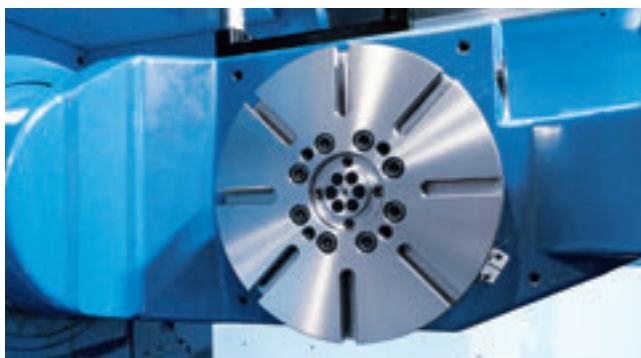

Excellent Access to the Machining Enclosure

Accessibility to workpiece and spindle

Operator comfort and efficiency is at the heart of the **MX-330** design. The main access door offers a generous 650mm of opening width, facilitating safe, fast & smooth load / unload operations. The distance from the front face of the machine to the center of the table is 385 mm, securing ergonomic access to the workpiece and spindle.

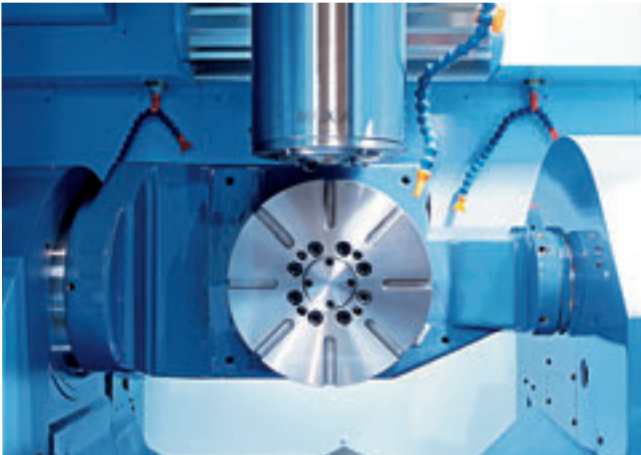

Minimal interference between the spindle head & table, offering excellent workpiece access to the cutting tool.

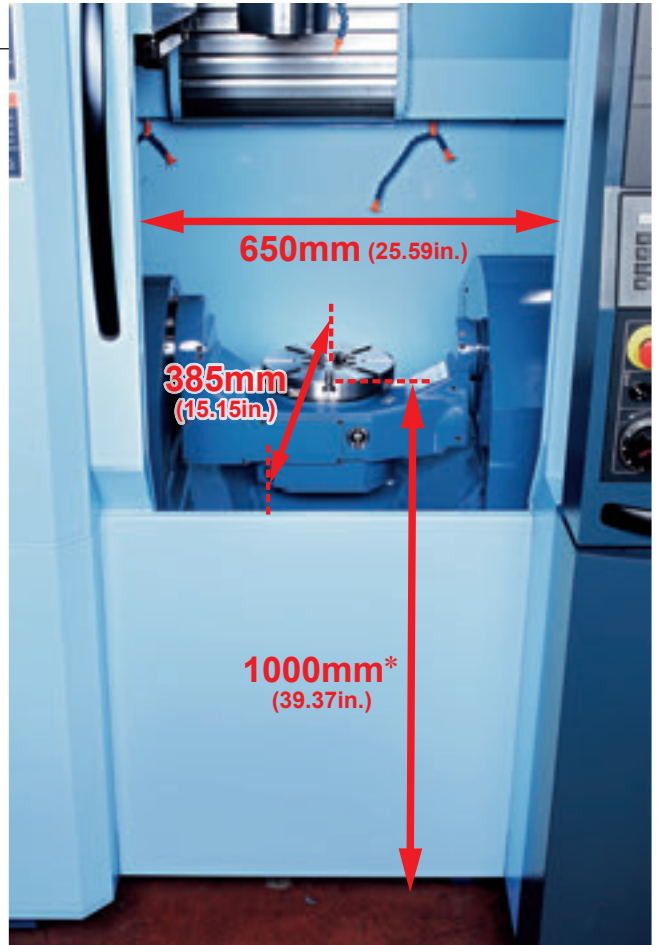

*Pallet specification is 1020mm (40.15in.)

Simple & Safe ATC Access

ATC door offers ample space & visibility for tool set up & maintenance operations.



Standard 30-tool drum magazine

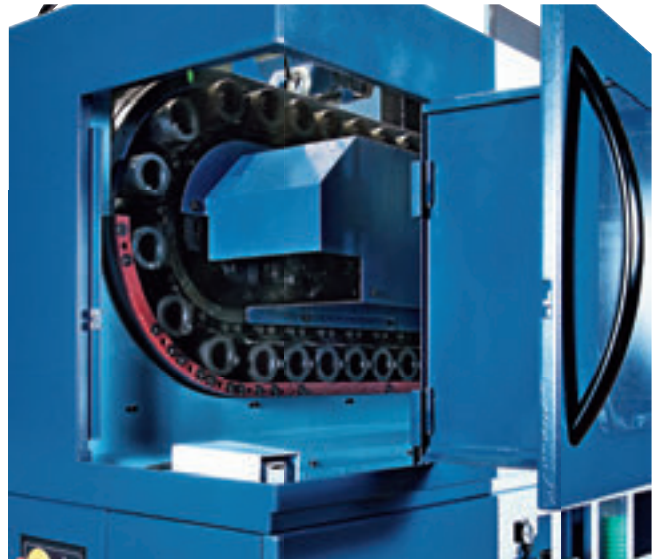

Option 60-tool chain magazine

Automation & Unmanned Production Package Option

Matsuura's legendary unmanned running technology with the **MX-330** comes in the form of a 10 pallet (CAPTO C6 compatible) and 90 tool option; offering superb profit enhancing lights out production utilizing minimal floor space

Automation Package

Option

Pioneers of reliable unmanned production, the 10 pallet, 90 tool specification of the **MX-330** is carefully weighted to offer maximum return on investment. Each of the 10 pallets can accommodate ϕ 330 mm x H 300mm Max. workpiece size.

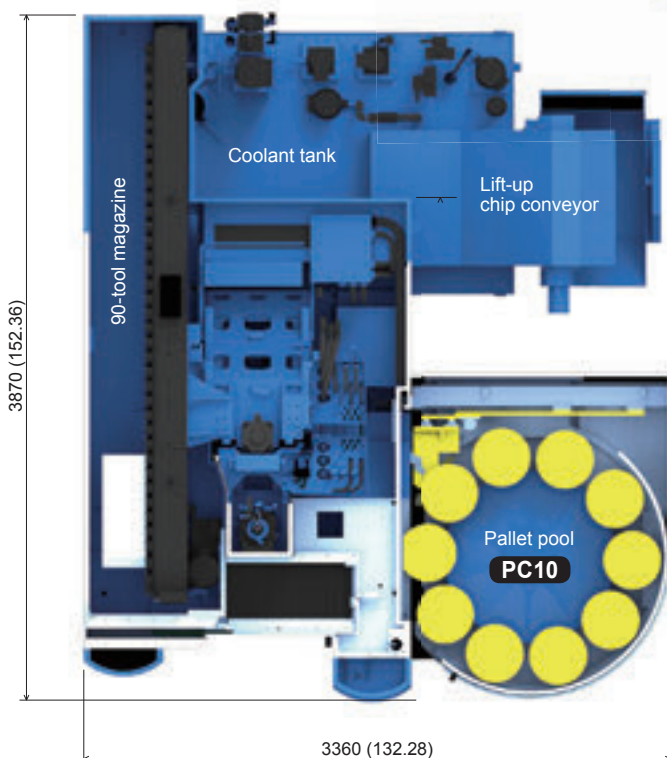

Item		Specifications
ATC		90tool
APC	Number of pallets	10 (Floor pallet system)
	Pallet type	CAPTO C6
Through-pallet		3 ports (Max. 19.6 MPa) Option

Work station

Standard

Work station access allows the set up of three pallets (A, B & C as shown) simultaneously.

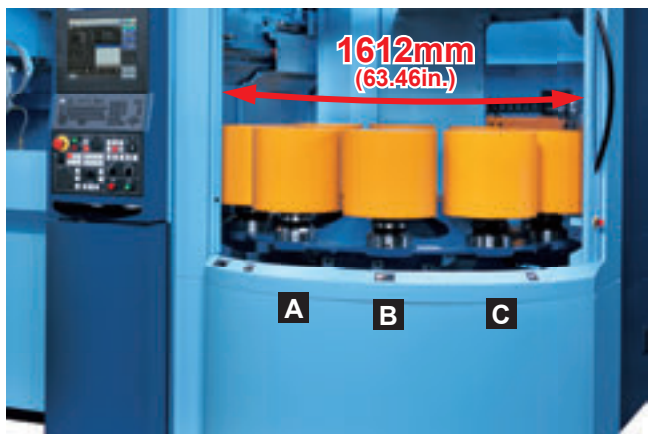

Work station (rotary)

Option

Rotary mechanism provided in the B position increases setup efficiency. Setup is possible by turning 90 degrees.

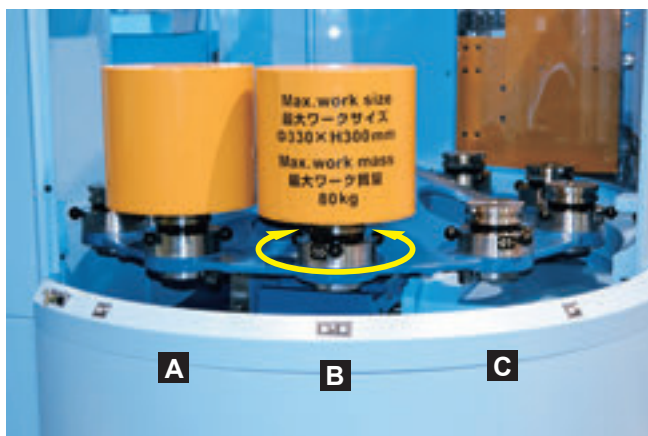

PC1 (single pallet) CAPTO C6

Option

CAPTO C6, which excels at high-accuracy positioning and repeat accuracy, is adopted. Pallets are the same as for **MAM72-35V** allowing common use of fixtures.

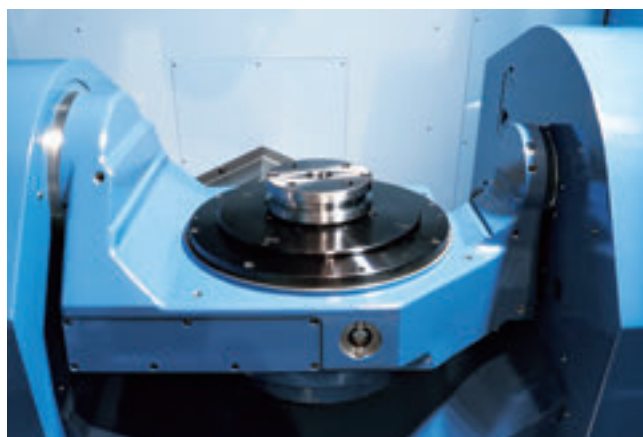

Three-port pressure supply system to fixtures

Option

Equipped with pressure supply ports for through-pallet-system fixtures. Supports pressures of up to 19.6 MPa.

Automation with a robot

Robot interface + Automatic door

Option

Interface for connection with external workpiece transfer systems

Toward Full-Spec. Automation Smooth step-up from ***MX-330*** possible



5-Axis Vertical Machining Center

MAM72-35V

The ***MX-330*** and our established ***MAM72-35V*** 5 axis machines both utilize CAPTO C6 pallets, offering seamless interaction and deployment of pallets and fixtures between both machines

Operating Convenience Allowing Even Beginners to Use it With Confidence

MIMS **Matsuura Intelligent Meister System**

Combining Craftsmanship, Skill and Ingenuity

Matsuura's original interface with uncompromising pursuit of usability

Environment	Eco Meister	Accuracy	Thermal Meister
	Eco mode		Stable accuracy
	Power savings		<input type="checkbox"/> Spindle thermal displacement compensation <input type="checkbox"/> Environmental thermal displacement compensation Option
Simple	Operability Meister	Secure	Reliability Meister
	Hassle-free, simple operation		Reduced machine downtime
	<input type="checkbox"/> Power cut-off function <input type="checkbox"/> Energy-saving devices installed <input type="checkbox"/> Eco-operation		<input type="checkbox"/> Preventive maintenance support function <input type="checkbox"/> Machine recovery support function <input type="checkbox"/> Electronic manual function <input type="checkbox"/> E-mail transmission function

New Operation Panel

Matsuura G-Tech 31i

Equipped with a large 15-inch touch screen display, the **Matsuura G-Tech 31i** offers genuine ergonomic comfort & sustained operator performance

- Icons required for operation, setup and maintenance are displayed on screen.
- Screen icons required for each task - "Operation", "Setup", "Maintenance" - are displayed.
- Screen switching response time is improved by 50% compared to conventional panels.
- USB thumb drives and CF cards are also supported for data input/output.
- Customization is possible according to tasks to be performed.



Program management



Tool offset



Electronic manual display



Intelligent Protection System Option

Manual / Automatic operation Simultaneous 5-axis machining

This collision protection function is developed solely by **Matsuura**. It prevents machine collisions due to programming errors in automatic operation, and also prevents human error in advance during manual operation and workpiece setup.

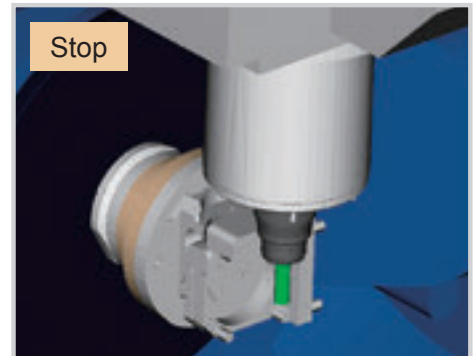

■ On-line link with PC



PC



Machining center

* **The Intelligent Protection System** simulates your programmed components (tools, workpiece, fixtures, etc.) that match the machine model, alerting you to any possible interference or collision before actual machining takes place.

* Prepare a PC on your side. Contact **Matsuura** for PC requirements.

Synchro Tip + Orbit machining Option Patent No. 5883535

Simple turning function combining orbit machining and C-axis rotation

Turning processes can also be performed on this machining center by using a synchro chip. Since turning and machining can now be done in one process no additional setup time is required for the turning process.

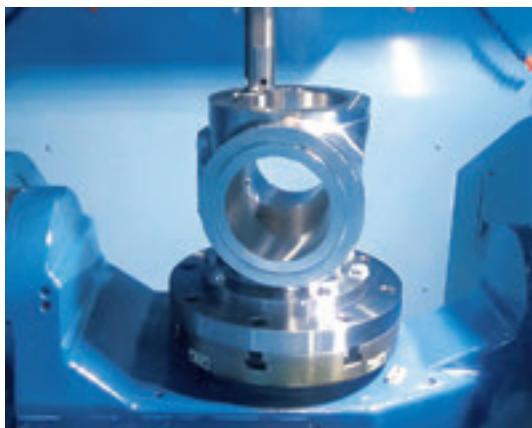

* **Synchro Tip** (Orbit machining + C-axis rotation)

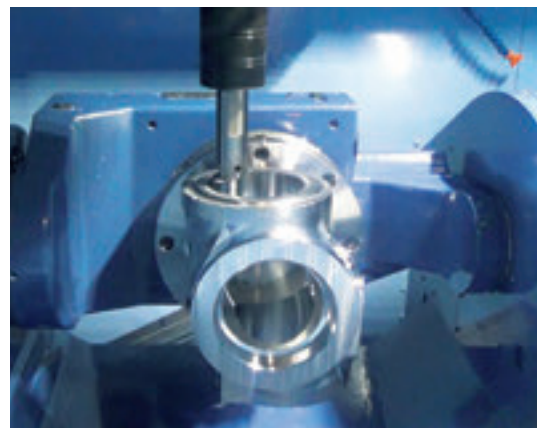

* Orbit function

eZ-5 Option

Advanced 5-axis error measurement and correction

Geometric error correction is essential for multi-axis machine tools. eZ-5 completes measurement, using a touch probe and calibration sphere, in a mere 3 minutes. The high accuracy of the machine is maintained through quick and simple operations.

* eZ-5 requires a separately available NC option to add macro variables.



Rapid Metal Removal Requires Ultra Efficient Chip Flow & Swarf Clearance

Smooth and Efficient Swarf management – by Design

Steep angle gradients on telescopic guard covers & internal surfaces & powerful coolant wash system facilitate the rapid despatch of chips and swarf from the machining enclosure, delivering maintenance free extended machining without the need for manual intervention. For environments where vast amounts of metal removal take place, the options below are available.

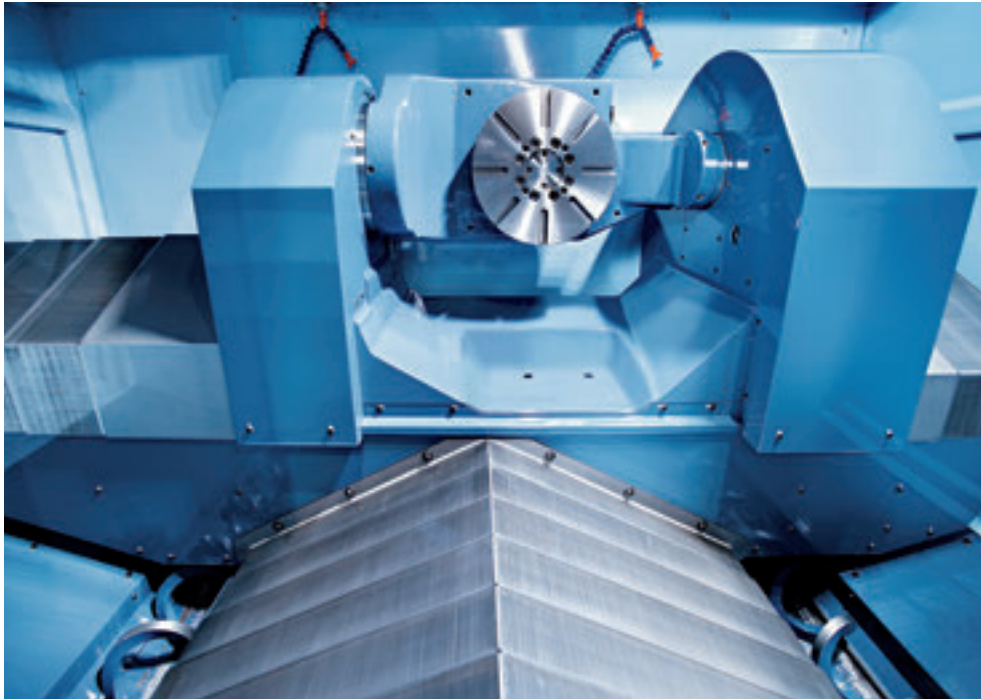

Standard Chip-flush coolant

Option Spiral chip conveyor

Standard Chip-flow coolant



Standard Coolant tank



Option Lift-up chip conveyor (back disposal)

Option Chip bucket



Option Lift-up chip conveyor (side disposal)

Option Chip bucket

Top view Unit: mm (in.)

Table top view **Standard**

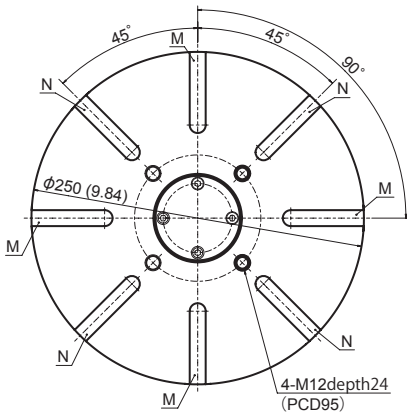

With through-table **Option**

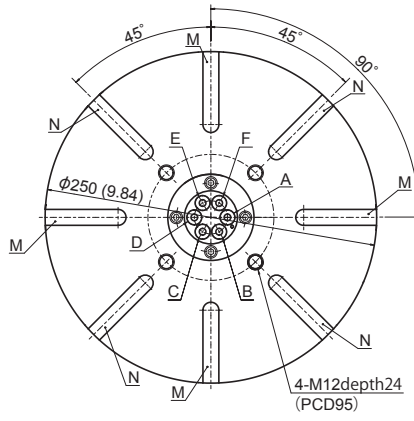

Pallet top view **Option**

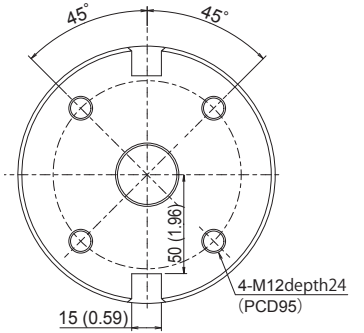

* A-F is a Port Number (PCD25)

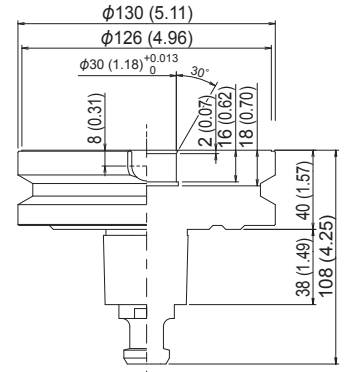
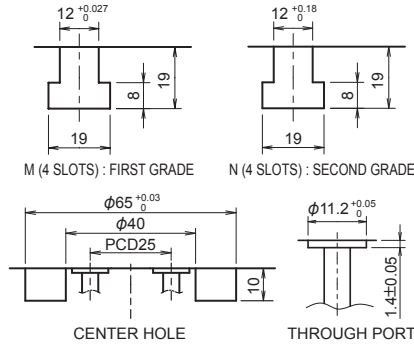
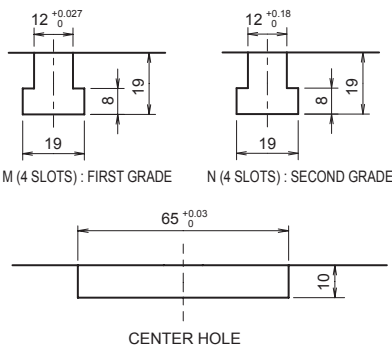

Stroke diagram Unit: mm (in.) **Standard**

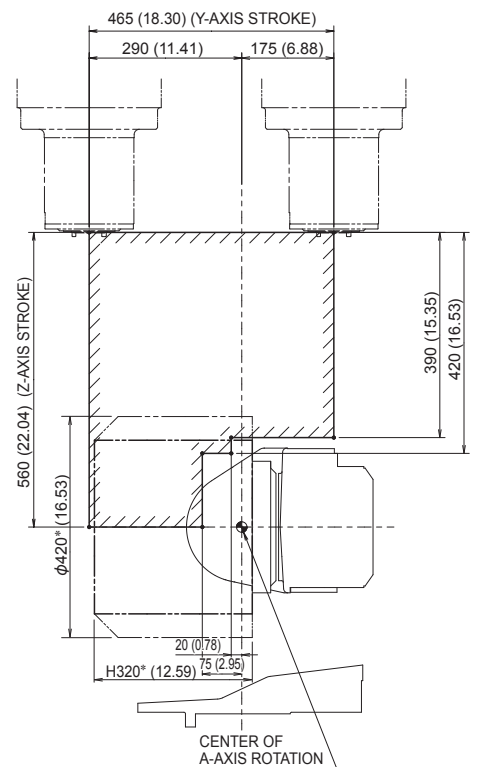
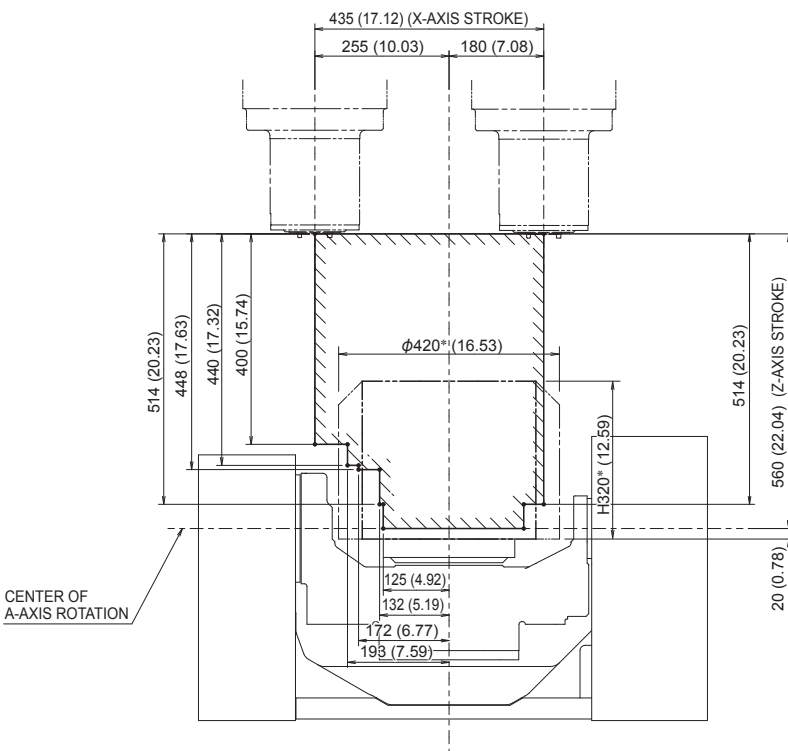

*Max. workpiece size

Standard Machine Specifications

■ Movement and Ranges		
X-axis stroke	mm (in.)	435 (17.13)
Y-axis stroke	mm (in.)	465 (18.31)
Z-axis stroke	mm (in.)	560 (22.05)
A-axis rotation angle	deg	-125 ~ +10
C-axis rotation angle	deg	360
■ Table		
Working surface	mm (in.)	φ 250 (φ 9.84)
Loading capacity	kg (lb.)	80 (176)
Max. workpiece size	mm (in.)	φ 330×H320 (φ 12.99×H12.59) φ 420×H320 (φ 16.53×H12.59) (with restrictions)
■ Spindle		
Spindle speed	min ⁻¹	50 ~ 15000 (auto grease lubrication)
Spindle speed change command	—	S5 digits direct command
Type of spindle taper hole	—	7/24 taper #40 (BT double contact type)
Spindle bearing inner diameter	mm (in.)	φ 70 (φ 2.75)
Spindle motor output	kW	AC5.5/7.5
Max. spindle torque	N·m	65.1
■ Feedrate		
Rapid traverse rate X / Y / Z	mm/min (ipm)	40000 (1574.8)
A / C	min ⁻¹	17 / 33
Feedrate X / Y / Z	mm/min (ipm)	1 ~ 40000 (0.03 ~ 1574.8)
A / C	min ⁻¹	17 / 33
■ Automatic Tool Changer		
Type of tool shank	—	JIS B 6339 tool shank 40T
Pullstud	—	JIS B 6339 pullstud 40P
Tool storage capacity	tools	30 (Drum magazine)
Max. tool diameter	mm (in.)	φ 80 (φ 3.14) (With adjacent tools) φ 150 (φ 5.90) (Without adjacent tools)
Max. tool length	mm (in.)	300 (11.81)
Max. tool mass	kg (lb.)	10 (22.05)
Method of tool selection	—	Memory random system

■ Power Sources		
Electrical power supply	kVA	31 (Depends on the options provided)
Power supply voltage	V	AC 200 / 220 ± 10% Transformer required for the voltage except above
Power supply frequency	Hz	50 / 60 ± 1
■ Tank Capacity		
Coolant tank capacity	L	350
Oil cooler tank capacity	L	4 (Total capacity: 6)
■ Machine Size		
Machine weight	kg (lb.)	6300 (13860)
■ NC System		
Control system	—	Matsura G-Tech 31i
■ Standard Accessories		
01. Total splash guard	02. ATC magazine guard	
03. ATC auto door	04. Spindle oil cooler	
05. Auto grease supply unit for feed axes	06. Scale feedback (A/C axis)	
07. Coolant unit	08. Chip flush	
09. Chip flow	10. Work light	
11. Synchronized tapping function	12. AD-TAP function	
13. IPC function	14. Spindle overload protection function	
15. M-code counter (9 kinds)	16. Spindle thermal displacement compensation system	
17. Software tool for memory card program operation & editing		
18. MIMS (Matsura Intelligent Meister System)	19. Integrating spindle run hour meter	
20. Integrating auto run hour meter	21. Service tools and tool box	
22. Machine color paint	23. Leveling bolts, leveling plates	
24. Electronic manual	25. E-mailing function	
26. Fault diagnosis function		

* 2 years spindle warranty

Floor plan Unit: mm (in.)

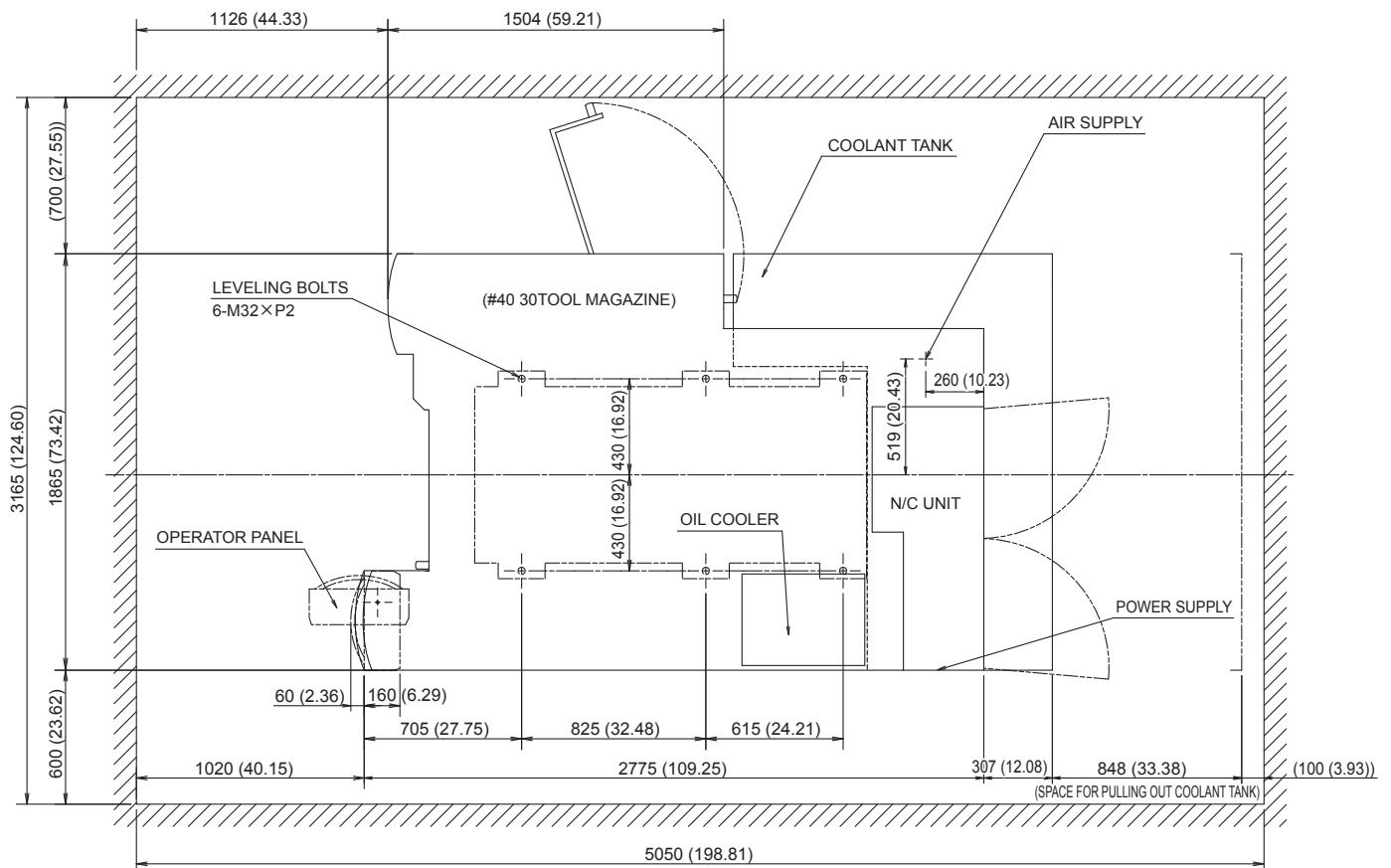

List of Fittings

○ : Standard ▲ : Option

■ Spindle		
15000min ⁻¹ (BT40 auto grease lubrication)		○
15000min ⁻¹ (BT40 auto grease lubrication)		
Spindle motor output	kW	Low: 7.5 / 15、High: 7.5 / 15
Max. spindle torque	N·m	119.3
20,000min ⁻¹ (BT40 auto grease lubrication)		
Spindle motor output	kW	Low: 11 / 15、High: 15 / 18.5
Max. spindle torque	N·m	108.4
■ Tool Storage Capacity		
30 tool (Drum magazine)		○
60 tool (Chain magazine)		▲
90 tool (Chain magazine)		▲
■ Number of Pallets		
1 (Single pallet) *1		▲
10 (Floor pallet system) *2		▲
■ Automation Package		
Automation package (PC10 , 90tools , Spiral)		▲
■ High Accuracy Control		
Scale feedback X-/Y-/Z-axis		▲
Environmental thermal displacement compensation (15000min ⁻¹ spindle)		▲
Environmental thermal displacement compensation (20000min ⁻¹ spindle)		▲
■ Coolant		
Vacuum type coolant through A 7MPa		▲
Vacuum type coolant through A 14MPa		▲
Vacuum type coolant through B 7MPa		▲
Vacuum type coolant through B 14MPa		▲
Vacuum type coolant through C 2MPa		▲
Vacuum type coolant through C 7MPa		▲
Mist separator (without fire damper)		▲
Mist separator retrofitting		▲
Coolant temperature controller with tank 100L		▲
■ Automatic Measurement, Tool Breakage Detection		
Automatic measurement / automatic alignment (optical , RENISHOW)		▲
Automatic measurement / automatic alignment (optical , BLUM)		▲
Tool breakage / full automatic tool length measurement (laser , BLUM)		▲
Tool breakage / full automatic tool length measurement (laser , RENISHOW)		▲
External tool breakage (30tools , contact)		▲
External tool breakage (60tools , contact)		▲
External tool breakage (90tools , contact)		▲

*1 Max. workpiece size : $\phi 420 \times H300$ (mm)
 *2 Max. workpiece size : $\phi 330 \times H300$ (mm)

■ Chip Removal	
Chip bucket	▲
Spiral chip conveyor	▲
Lift-up chip conveyor (scraper)	▲
Air blow for chip removal	▲
Workpiece cleaning gun (machine side)	▲
■ Operation/Maintenance Support	
Intelligent Protection System	
Reliability Meister Plus Type A (with PC)	▲
Reliability Meister Plus Type B (without PC)	▲
Additional eight M functions	▲
Spindle load monitoring function	▲
Weekly timer	▲
3-color signal light (red, yellow, green from top)	▲
Optional block skip addition 2 to 9	▲
External manual pulse generator	▲
eZ-5 (with calibration sphere)	▲
eZ-5 (without calibration sphere)	▲
Pressure supply system for fixtures	▲
Rotary wiper (Air)	▲
Rotary wiper (Electric)	▲
OP auto door	▲
Robot interface + auto door	▲
Robot + auto door	▲
■ Optional Package	
High-speed, high-precision package	▲
5-axis package	▲
High-speed, high-precision 5-axis package	▲

■ Tool breakage / full automatic tool length measurement (laser) Option



External view Unit: mm (in.) Standard

Left side view

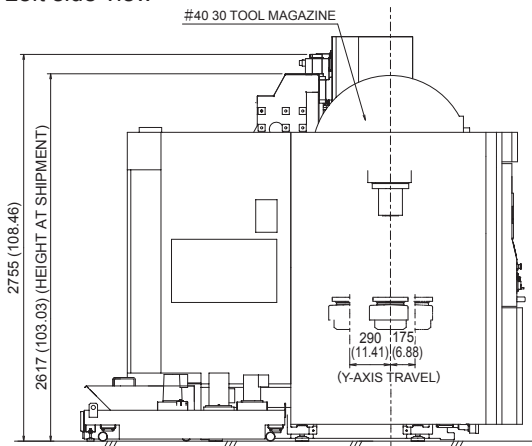

Front view

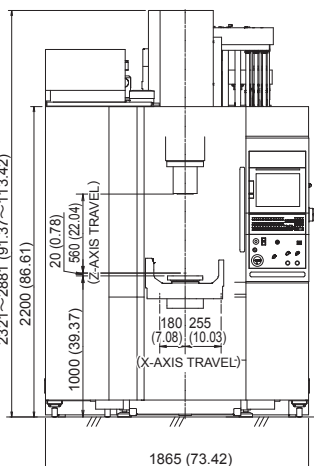

Right side view

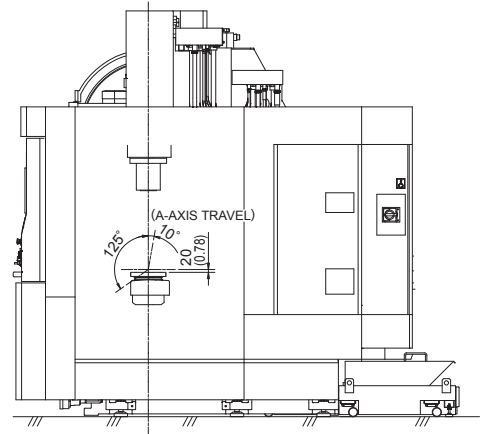



Matsuura

URL : <http://www.matsuura.co.jp/>

E-MAIL : webmaster@matsuura.co.jp

MATSUURA MACHINERY CORPORATION

1-1 Urushihara-cho Fukui City 910-8530, Japan

TEL : +81-776-56-8106 FAX : +81-776-56-8151

MATSUURA EUROPE GmbH

Berta-Cramer-Ring 21

D-65205 Wiesbaden-Delkenheim, Germany

TEL : +49-6122-7803-80 FAX : +49-6122-7803-33

URL : <http://www.matsuura.de/>

E-MAIL : info@matsuura.de

MATSUURA MACHINERY Ltd.

Gee Road, Whitwick Business Park, Coalville Leicestershire, LE67 4NH, England

TEL : +44-1530-511-400 FAX : +44-1530-511-440

URL : <http://www.matsuura.co.uk/>

E-MAIL : sales@matsuura.co.uk

MATSUURA MACHINERY GmbH

Berta-Cramer-Ring 21

D-65205 Wiesbaden-Delkenheim, Germany

TEL : +49-6122-7803-0 FAX : +49-6122-7803-33

URL : <http://www.matsuura.de/>

E-MAIL : info@matsuura.de

ELLIOTT MATSUURA CANADA INC.

2120 Buckingham Road Oakville Ontario L6H 5X2, Canada

TEL : +1-905-829-2211 FAX : +1-905-829-5600

URL : <http://www.elliottmachinery.com/>

E-MAIL : sales@elliottmachinery.com

MATSUURA MACHINERY USA INC.

325 Randolph Ave., St.Paul, MN 55102, U.S.A.

TEL : +1-651-289-9700

URL : <http://www.matsuurausa.com/>

E-MAIL : info@matsuurausa.com

-
- Product specifications and dimensions are subject to change without prior notice.
 - The photos may show optional accessories.

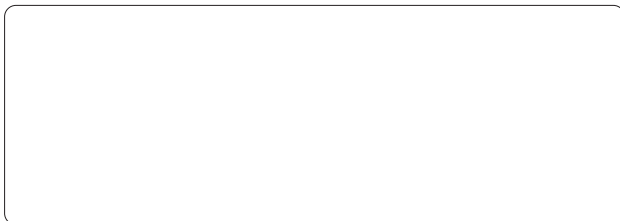

This product is subject to all applicable export control laws and regulations

